



INSTITUTE FOR TESTING AND CERTIFICATION, a.s.

Testing Laboratory of Electrical Products
Sokolovska 573
686 01 Uherske Hradiste
Czech Republic



TESTING LABORATORY No. 1004.3

Accredited by the Czech Institute for Accreditation, o. p. s
According to ČSN EN ISO/IEC 17025:2018

Test Report No: 414105232AE4

Number of Copies: 2

Copy No.: 2

TEST REPORT

ABOUT THE ELECTROMAGNETIC COMPATIBILITY TEST

of the PX310/R



.....
Test Engineer and Report Author:

Mr. Vlastimil Vaculík

.....
Head of Testing Laboratory:

Mr. Pavel Vavra

Issue Date: 2023-05-26

Number of pages: 16

Number of Appendices: 0

Distribution List: Institute for testing and certification (Copy No. 1)
Applicant (Copy No. 2)

No partial reproduction of this Test Report is allowed without a prior written permission of ATL 1004.3, except the case when reproduced in its entirety.

The test results mentioned below relate solely to the Equipment under Test as received. The laboratory disclaims any responsibility for the information provided by the applicant.

1. GENERAL SPECIFICATIONS

* - out of scope of accreditation

** - information provided by the applicant

1.1. Equipment Under Test (EUT)

One sample of the PX310/R with serial number 4304053 was delivered to Institute for testing and certification on 2023-05-02. ATL 1004.3 started the requested test under Job No 414105232.

Picture 1.1.A – EUT

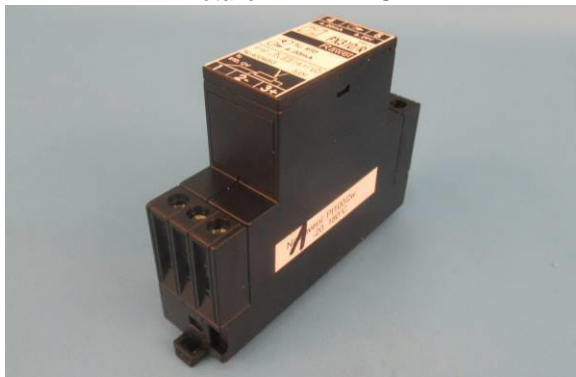

Picture 1.1.B – Marking label

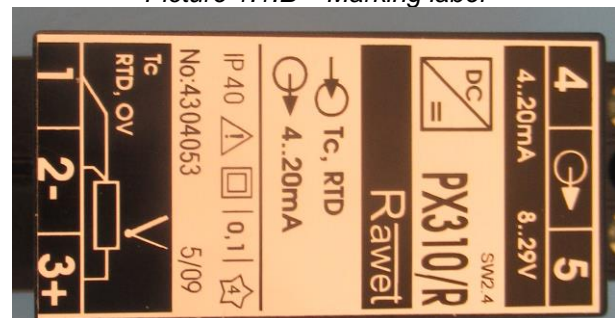

1.2. Applicant

Rawet s.r.o.
Čapkova 22
678 01 Blansko
Czech Republic

Company ID: 47901411
VAT No.: CZ47901411

Order No.:
as of: 2023-03-08

1.3. Manufacturer

Rawet s.r.o.
Čapkova 22
678 01 Blansko
Czech Republic

1.4. Test Period

Started on: 2023-05-02
Finished on: 2023-05-04

1.5. Test Conditions

Ambient temperature:(+15 up to +35) °C

Barometric pressure: (86 up to 106) kPa

Relative humidity: (30 – 60) %

1.6. Place of Tests

Accredited testing laboratory 1004.3

Sokolovská 573

686 01 Uherské Hradiště

Czech Republic

1.7. Regulations Used

<i>i</i>	<i>Regulation used</i>	<i>As Czech implementation of</i>
1	ČSN EN 50155 ed.5:2022	EN 50155:2021
2	ČSN EN 50121-3-2 ed.4:2017 + A1:2019	EN 50121-3-2:2016 + A1:2019
3	ČSN EN IEC 61000-6-4 ed.3:2019	EN IEC 61000-6-4 ed.3:2019
4	ČSN EN 55016-2-1 ed.3:2015 + A1:2018	EN 55016-2-1:2014 + A1:2017
5	ČSN EN 55016-2-3 ed.4:2017 + A1:2020	EN 55016-2-3:2017 + A1:2019
6	ČSN EN 61000-4-2 ed.2:2009	EN 61000-4-2:2009
7	ČSN EN IEC 61000-4-3 ed.4:2021	EN IEC 61000-4-3:2020
8	ČSN EN 61000-4-4 ed.3:2013	EN 61000-4-4:2012
9	ČSN EN 61000-4-5 ed.3:2015 + A:2018	EN 61000-4-5:2014 + A1:2017
10	ČSN EN 61000-4-6 ed.4:2014	EN 61000-4-6:2014

1.8. Test Instruments and Equipment

<i>i</i>	<i>Instrument / Equipment</i>	<i>Serial No</i>
1	Test Receiver Rohde & Schwarz ESIB 7	100318
2	Artificial Network RWMO US4 25-50	000422
3	Log-periodic antenna Frankonia BTA-H	97061002
4	Horn antenna BBHA 9120 D	02284
5	RF generator R&S SMB 100A	181 902-Jc
6	RF amplifier AR 75A250	307997
7	RF amplifier BONN BLMA 1060-50	2012763
8	RF amplifier Frankonia FLH-200B1 rev.D	1055/1741
9	ESD generator Haefely PESD 3010	H805224
10	Burst generator Haefely PEFT-Junior	583333-82
11	Capacitive clamp 093.506.1	080 184-1
12	Generator Haefely PSURGE 4010	080888/07

<i>i</i>	<i>Instrument / Equipment</i>	<i>Serial No</i>
13	Coupling network IP 6.2	145348
14	Decoupling network DEC1A	145312
15	Coupling network MEB M3	14413
16	EM clamp KEMZ 801	14299
17	Current probe FCC F120	459
18	Power supply Statron 2225.4	1711021
19	Current meter ML10	428178

All listed equipment subjected calibration has been duly calibrated and they passed a regular metrological inspection.

1.9. EUT Installation

EUT was powered by the DC power supply, supply voltage 24V. The current meter was used in the input power cable. The resistor 150R was connected to the input of the EUT. The input and power cable were length more than 3m.

Picture 1.9.A – Block Schematic

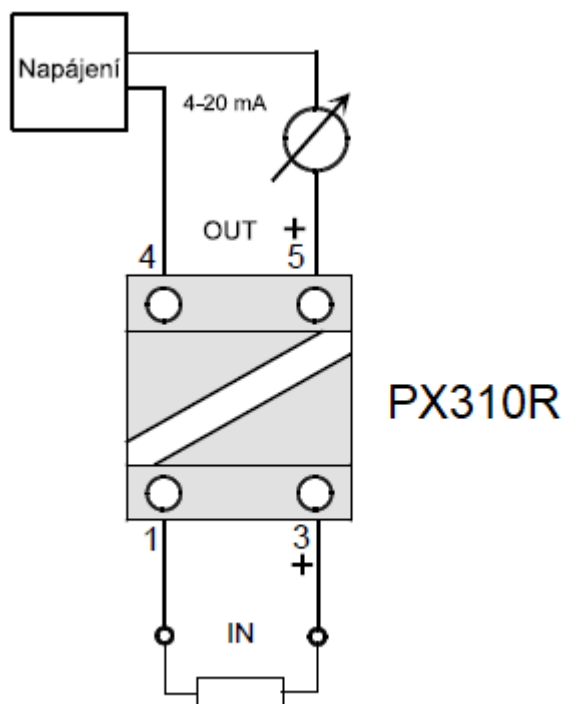

2. EMC TESTS OF RADIATED INTERFERENCE

EUT was connected according to clause 1.9. The EUT was tested in the operation mode.

Picture 2.A – EUT during the test



2.1. Measurement of Conducted Emission

Requirement in	ČSN EN 50155 ed.5 clause 13.4.9, ČSN EN 50121-3-2 ed.4, clause 7, table 1, ČSN EN IEC 61000-6-4 ed.3, clause 9
Testing method	ČSN EN 55016-2-1 ed.3 clause 7.4.1
Test specification	<p>Measuring of the levels of spurious terminal voltages, radiated by the EUT into the supply leads on frequency band of 0.15 up to 30 MHz.</p> <p>The EUT was placed on the wooden table 80 cm above the ground reference plane in a shielded semi anechoic chamber. The EUT was in the operation mode during the test.</p> <p>The spurious voltage levels were measured on the supply terminals of the EUT using the Selective Micro-voltmeter with a quasi-peak and average detector.</p>
Measurement uncertainty	U = ± 3.5 dB (specified for the coverage coefficient k = 2 and the confidence probability of 95 %)
Results	PASSED

Limits of the conducted spurious voltage according to ČSN EN 50121-3-2 ed.4, clause 7, table 1

Frequency band (MHz)	Limits dB (µV)	
	Quasi-Peak values	Average values
0.15 up to 0.50	99	
0.5 up to 30	93	

NOTE 1 – The lower limit is valid for the frequency on boundary.

Graph 2.1.A – Conducted terminal voltage according to the ČSN EN 50121-3-2 ed.4, terminal +

Voltage on Mains

EUT: PX310/R
 Manufacturer: Rawet s.r.o.
 Operating Condition:
 Test Site:
 Operator: V.Vaculík
 Test Specification: +24V
 Comment:
 Start of Test: 2.5.2023 / 8:49:50

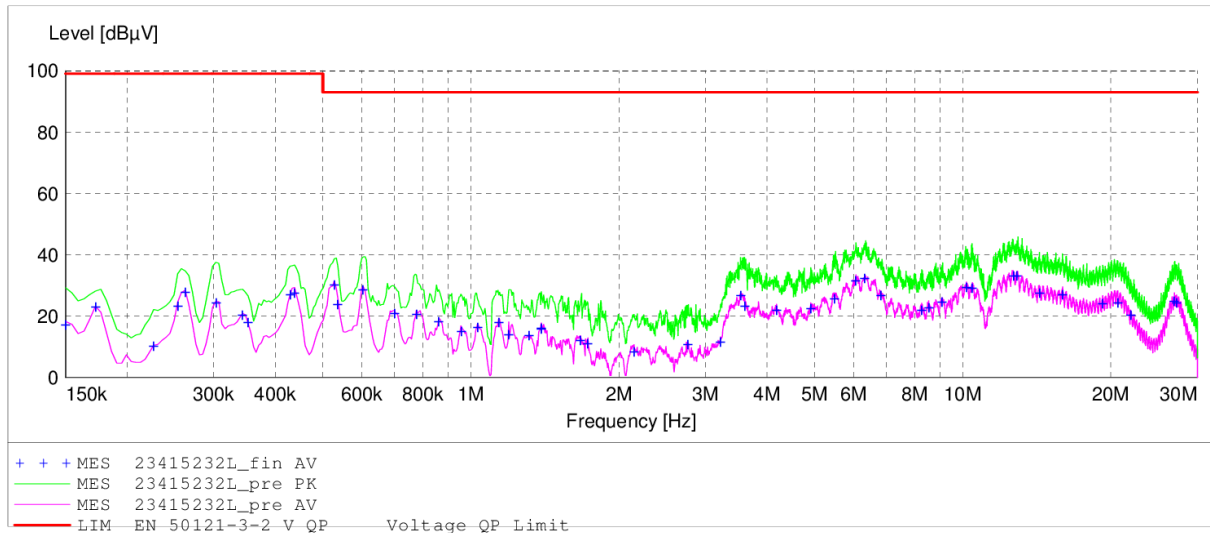

Graph 2.1.B – Conducted terminal voltage according to the ČSN EN 50121-3-2 ed.4, terminal -

Voltage on Mains

EUT: PX310/R
 Manufacturer: Rawet s.r.o.
 Operating Condition:
 Test Site:
 Operator: V.Vaculik
 Test Specification: GND
 Comment:
 Start of Test: 2.5.2023 / 8:55:04

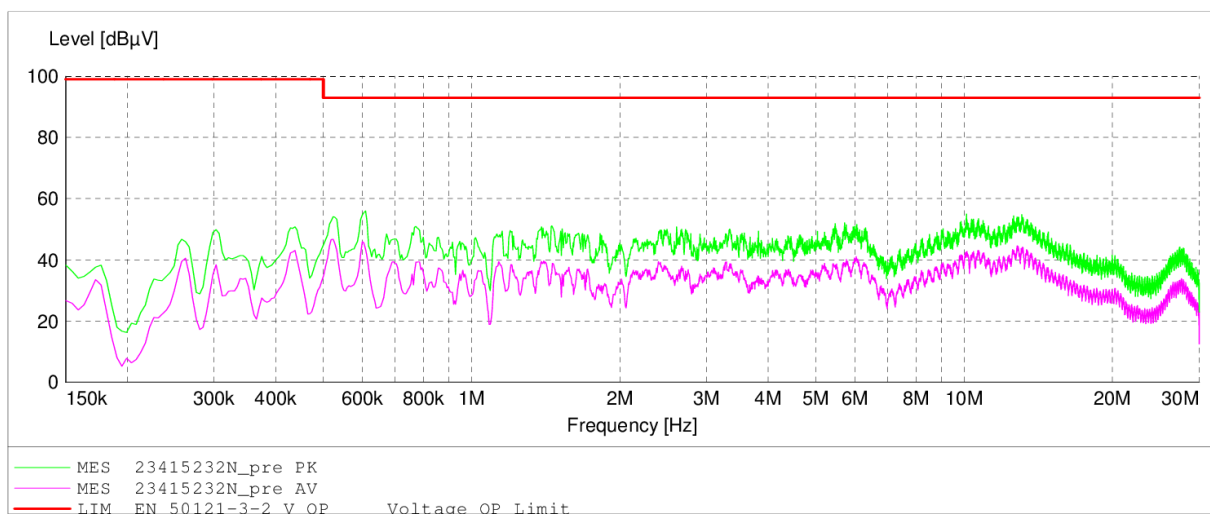

2.2. Measurement of Radiated Field

Requirement in	ČSN EN 50155 ed.5 clause 13.4.9, ČSN EN 50121-3-2 ed.4, clause 7, ČSN EN IEC 61000-6-4 ed.3, cause 9
Testing method	ČSN EN 55016-2-3 ed.4 cause 7
Test specification	The field strength levels, radiated by the EUT into environment on frequencies 30 up to 1,000 MHz. The EUT was situated on the wooden table 80 cm above ground reference plane in the shielded semi-anechoic chamber. The EUT was in the operational mode during the test. The measurement was carried out in the semi-anechoic chamber at the distance of 3 m / 9.8 ft and recalculated for the distance of 10 m / 32.8 ft. The Selective Micro-voltmeter with a quasi-peak detector was connected to the measuring antenna. The values of radiated electromagnetic field were subsequently measured at horizontal as well as vertical polarization of the measuring antenna. The maximum of emission was searched for horizontal and for vertical polarization by rotation of device and by turning the high of antenna.
Measurement uncertainty	U = ± 5.2 dB (specified for the coverage coefficient k = 2 and the confidence probability of 95 %)
Results	PASSED

Limits of the radiated emissions (measuring distance 10 m) according to ČSN EN IEC 61000-6-4 ed.3, Table 3

Frequency range (MHz)	Quasi-Peak limits dB (µV/m)
30 up to 230	40
230 up to 1000	47

NOTE 1 – The lower limit is valid for the frequencies on the boundaries of bands.

Graph 2.2.A – radiated emissions according to ČSN EN IEC 61000-6-4 ed.3, horizontal

Electric Field Strength

EUT: RX310/R
 Manufacturer: Rawet s.r.o.
 Operating Condition:
 Test Site:
 Operator: V.Vaculík
 Test Specification: Horizontal
 Comment:
 Start of Test: 2.5.2023 / 8:58:22

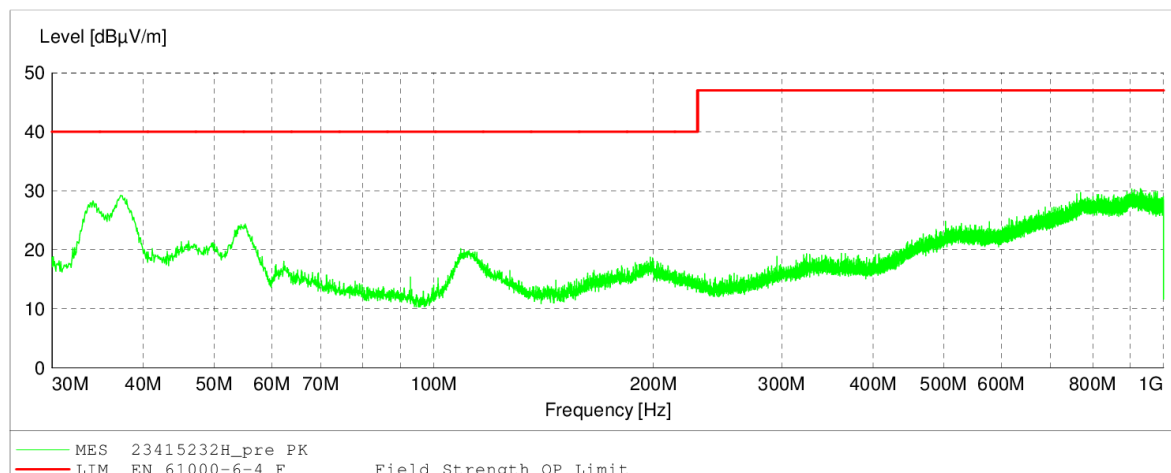

Graph 2.2.B – radiated emissions according to ČSN EN IEC 61000-6-4 ed.3, vertical

Electric Field Strength

EUT: RX310/R
 Manufacturer: Rawet s.r.o.
 Operating Condition:
 Test Site:
 Operator: V.Vaculík
 Test Specification: Vertical
 Comment:
 Start of Test: 2.5.2023 / 9:04:03

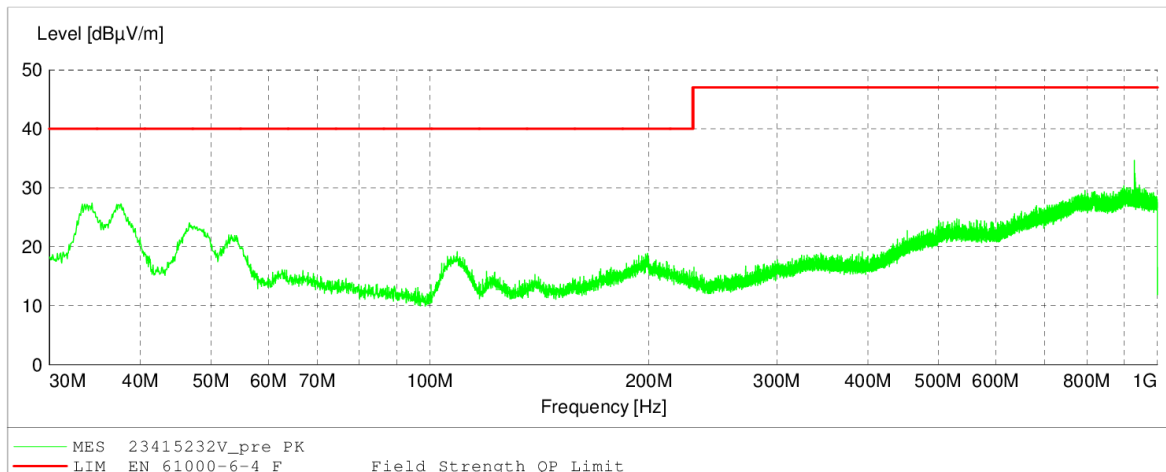

3. EMC IMMUNITY

The EUT was placed on the table for required test. The EUT was in the operation mode during the test - switching. The EUT was connected according to clause 1.9.

For criterion A - EUT function must not be influenced. Reset is not allowed. The measured values have to be in the tolerance of the manufacturer.

3.1. Electrostatic Discharge

Requirement in	ČSN EN 50155 ed.5, clause 13.4.9 ČSN EN 50121-3-2 ed.4, cause 8, table 5, item 5.3
Testing method	ČSN EN 61000-4-2 ed.2
Test specification	The air method was applied for non-conductive surfaces while contact discharges were used for conductive parts. The air method was applied to all non-conductive parts. The contact discharge method was applied to all metallic places. The EUT was placed on an insulating pad on the reference grounding surface. The test was performed in operation mode.
Results	PASSED, Performance Criterion A

Table 3.1.A – Performance of the EUT on discharges

Level	+ 2 kV	- 2 kV	+ 4 kV	- 4 kV	+ 6 kV	- 6 kV	+ 8 kV	- 8 kV
Contact Discharge	-	-	-	-	A	A	-	-
Air Discharge	-	-	-	-	-	-	A	A

A ... Performance Criterion A (no function of the EUT was affected)

Picture 3.1. A – Air discharge

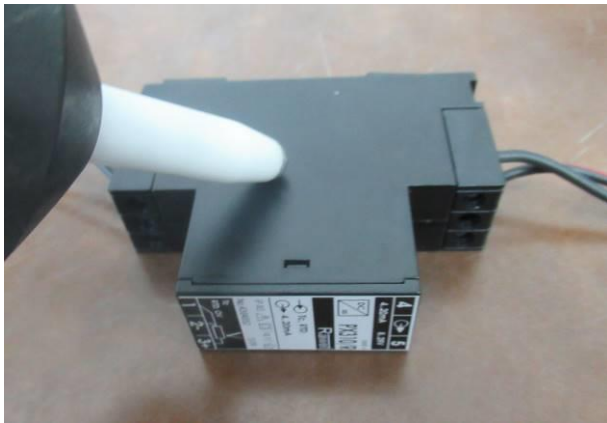

Picture 3.1. B – Air discharge

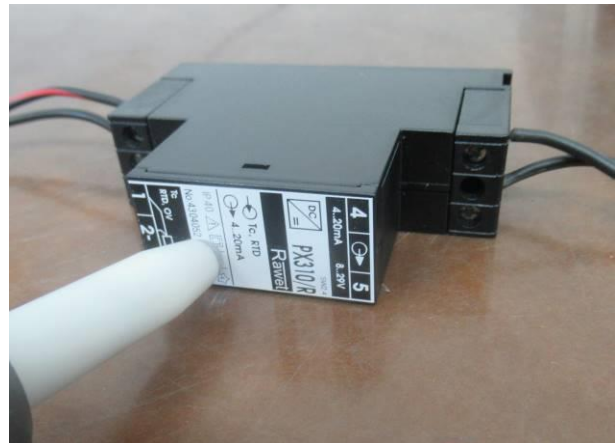

Picture 3.1. C – Contact discharge

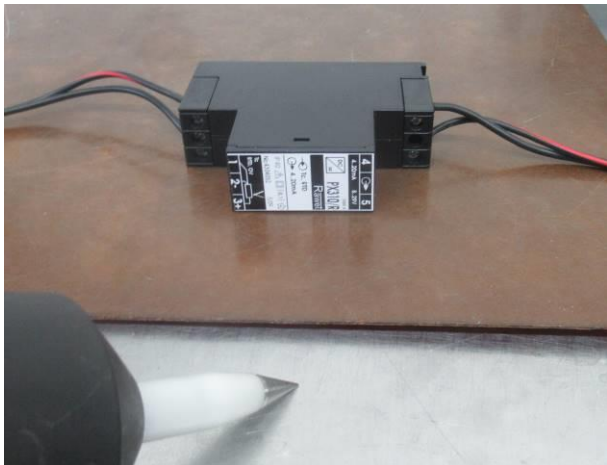

Picture 3.1. D – Contact discharge



3.2. Radiated Electromagnetic Field

Picture 3.2.A – EUT during testing field immunity

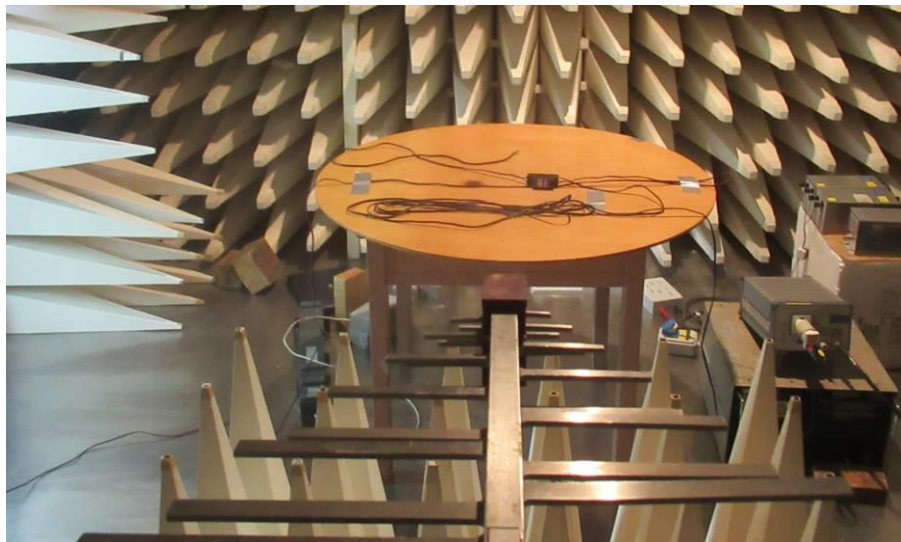

Requirement in	ČSN EN 50155 ed.5, clause 13.4.9 ČSN EN 50121-3-2 ed.4, cause 8, table 5, item 5.1, 5.2
Testing method	ČSN EN IEC 61000-4-3 ed.4
Test specification	The EUT was placed in the shielded anechoic chamber on the wooden table 0.8 m above the reference grounding surface. EUT was in the operation mode during the test.
Results	PASSED, Performance Criterion A

Table 3.2.A – field immunity test parameters

Maximal change frequency	1% logarithmic step
Time step	2s

Table 3.2.B – Field immunity test parameters and performance

Frequencies	AM	Mod. frequency	Polarization	Severity level [V/m]	Performance
80 MHz – 800 MHz	80%	1 kHz	Horizontal	20	A
800 MHz – 1 GHz	80%	1 kHz	Horizontal	20	A
1.4 – 2 GHz	80%	1 kHz	Horizontal	10	A
2 – 2,7 GHz	80%	1 kHz	Horizontal	5	A
5.1 – 6 GHz	80%	1 kHz	Horizontal	3	A
80 MHz – 800 MHz	80%	1 kHz	Vertical	20	A
800 MHz – 1 GHz	80%	1 kHz	Vertical	20	A
1.4 – 2 GHz	80%	1 kHz	Vertical	10	A
2 – 2.7 GHz	80%	1 kHz	Vertical	5	A
5.1 – 6 GHz	80%	1 kHz	Vertical	3	A

A ... Performance Criterion A (no function of the EUT was affected)

3.3. Electrical Fast Transients/Burst

Requirement in	ČSN EN 50155 ed.5, clause 13.4.9 ČSN EN 50121-3-2 ed.4, cause 8, table 3, item 3.2
Testing method	ČSN EN 61000-4-4 ed.3
Test specification	The pulse groups were injected directly into the individual supply leads. The EUT was placed 0.1 m / 0.33 ft above the reference grounding surface. The minimum distance from any metallic objects was more than 0.6 m / 1.97 ft. from the EUT. EUT was in the operation mode during the test.
Results	PASSED, Performance Criterion A

Table 3.3.A – Test parameters

Pulse group width	15 ms
pulse group period	300 ms
Repeating frequency of the pulse groups	5 kHz
Duration positive / negative pulses:	1 minute for each conductor

Table 3.3.B – Performances of the EUT on the fast transients/burst immunity tests

Amplitude	+1 kV	- 1 kV	+2 kV	- 2 kV
Input / Output cable	-	-	A	A

A ... Performance Criterion A (no function of the EUT was affected)

3.4. Surge Impulse

Requirement in	ČSN EN 50155 ed.5, clause 13.4.9 ČSN EN 50121-3-2 ed.4 , cause 8, table 3, item 3.3
Testing method	ČSN EN 61000-4-5 ed.3
Test specification	The EUT was placed 0.1 m / 0.33 ft above the reference grounding surface. The minimum distance from any metallic objects was more than 0.6 m / 1.97 ft. from the EUT. The surges were applied thru coupling network between the: <ul style="list-style-type: none"> • +24V – GND EUT was in the operation mode during the test.
Results	PASSED, Performance Criterion B

Table 3.4.A – Surge immunity test parameters

Shape of pulses	1.2/50 μ s open-circuit voltage, 8/20 μ s short-circuit current
Number of surges in a series	5
Interval between surges	10 s
Source impedance	42 Ω
Coupling capacitance	0,5 μ F

Table 3.4.B – Performances of the EUT - surge immunity test

Amplitude	+0,5 kV	-0,5kV	+1 kV	- 1 kV	+ 2 kV	- 2 kV
+24V – GND	A	B	B	B	-	-

A ... Performance Criterion A (no function of the EUT was affected)

B ... Performance Criterion B (impaired function of the EUT, function of the EUT was restored after the test) – measured values were out of tolerance of the manufacturer

3.5. Conducted Disturbances Induced by RF Fields

Requirement in	ČSN EN 50155 ed.5, clause 13.4.9 ČSN EN 50121-3-2 ed.4, cause 8, table 3, item 3.1
Testing method	ČSN EN 61000-4-6
Test specification	The conducted spurious signal was injected into the power conductors coupling network MEB M3 and to the communication cables using KEMZ801 and using current probe FCC. The EUT was placed on the wooden table 0.1 m / 0.33 ft above the reference grounding surface. EUT was in the operation mode during the test.
Results	PASSED, Performance Criterion A

Table 3.5.A – Field immunity test parameters

Maximal change of frequency	1% from previous value of frequency
Time step	2s

Table 3.5.B – Field immunity test parameters and performances

	Frequencies	AM	Mod. frequency	Severity level [V]	Performance
Input cable	150 kHz – 80 MHz	80%	1 kHz	10	A
Output cable	150 kHz – 80 MHz	80%	1 kHz	10	A

A ... Performance Criterion A (no function of the EUT was affected)

3.6. Tests EMC - Power Supply Range (Nominal voltage 24V DC)

Requirement in	ČSN EN 50155 ed.5, clause 13.4.3.2
Testing method	ČSN EN 50155 ed.5, clause 13.4.3.2
Result:	PASSED

Power supply voltage:	Value:	Performance - result
Nominal voltage (U_n)	24 V	A
Minimal continuous voltage ($0,7U_n$)	8 V	A
Maximal continuous voltage ($1,25U_n$)	30V	A

3.7. Tests EMC – Power supply Overvoltage (Nominal voltage 24V DC)

Requirement in	ČSN EN 50155 ed.5, clause 13.4.3.3
Testing method	ČSN EN 50155 ed.5, clause 13.4.3.3
Result:	EUT was powered using current circuit. Test was not performed.

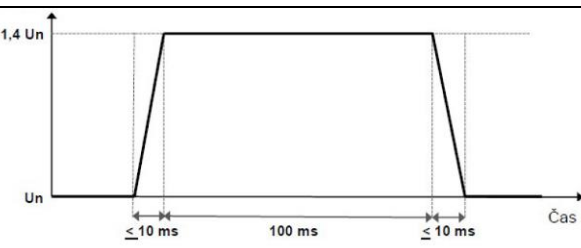
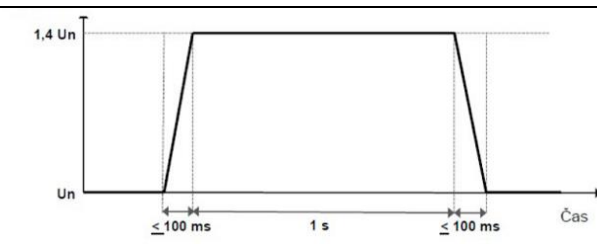
Temporary overvoltage (a):	Temporary overvoltage (b):
	
Number of fluctuations: 10	Number of fluctuations: 10
Interval between fluctuations: 10s	Interval between fluctuations: 10s
Overvoltage value: $1,4 U_n =$	Overvoltage value: $1,4 U_n =$
Result:	Result:

3.8. Tests EMC - Temporary Undervoltage

Requirement in	ČSN EN 50155 ed.5, clause 13.4.3.4
Testing method	ČSN EN 50155 ed.5, clause 13.4.3.4
Result:	EUT was powered using current circuit. Test was not performed.

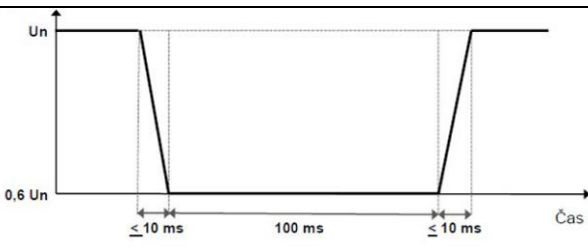
Temporary undervoltage	
 <p>The graph shows a voltage waveform. The vertical axis is labeled U_n and the horizontal axis is labeled $\check{c}as$. The voltage starts at a level U_n, then drops linearly to a level $0,6 U_n$. The duration of this drop is indicated as $\leq 10 \text{ ms}$. The voltage remains constant at $0,6 U_n$ for a duration of 100 ms. It then rises linearly back to the level U_n, with this rise also indicated as $\leq 10 \text{ ms}$.</p>	
Number of fluctuations: 10	
Interval between fluctuations: 10s	
Undervoltage value: $0,6 U_n =$	
Result:	

3.9. Interruptions of Voltage Supply

Requirement in	ČSN EN 50155 ed.5, clause 13.4.3.5
Testing method	ČSN EN 50155 ed.5, clause 13.4.3.5
Result:	EUT was powered using current circuit. Test was not performed.

Class	Performance criterion:	Duration of the interruption
S1	no performance criterion is requested	Note: due to clause 5.1.1.4 this test is not required
S2	Performance Criterion A	10 ms
S3	Performance Criterion A	20 ms

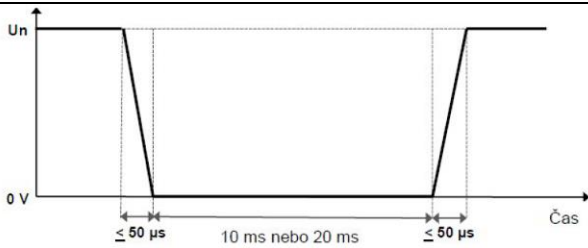
Interruptions of voltage supply	
	
Number of interruptions: 10	
Interval between interruptions: 10s	
Tested class:	
Nominal voltage $U_n =$	
Requirement in standard: Performance Criterion A	
Result:	

3.10. Supply Changeover

Requirement in	ČSN EN 50155 ed.5, clause 13.4.3.6
Testing method	ČSN EN 50155 ed.5, clause 13.4.3.6
Result:	EUT was powered using current circuit. Test was not performed.

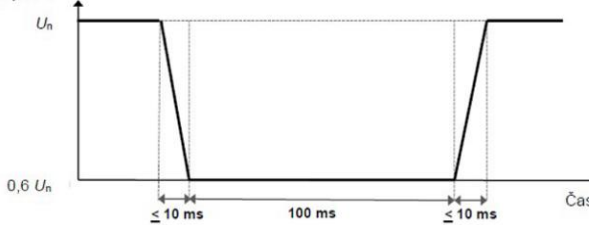
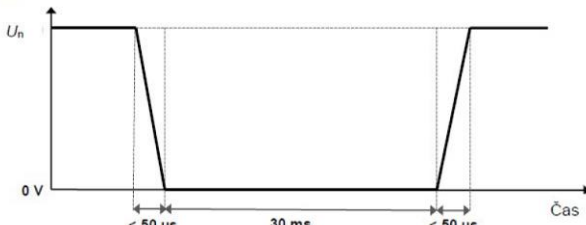
Class C1	Class C2
	
Number of interruptions: 10	Number of interruptions: 10
Interval between interruptions: 10s	Interval between interruptions: 10s
$0,6 U_n =$	$U_n =$
Requirement in standard: Performance Criterion A	Requirement in standard: Performance Criterion B
Result:	Result:



The stated expanded measurement uncertainty is the product of the standard uncertainty and the expansion coefficient $k = 2$, which for a normal distribution corresponds to a coverage probability of about 95%. Standard uncertainty was determined in accordance with EA 4/16.

ILAC-G8 decision rule used: 09/2019: 4.2.1 Binary statement for simple acceptance rule.

4. STATEMENT OF CONFORMITY

PPX310/R complies with requirements of the following regulations in the range of performed tests.

- **EN 50155:2021**
- **EN 50121-3-2:2016 + A1:2019**
- **EN IEC 61000-6-4:2019**
- **EN 61000-4-2:2009 Criterion A**
- **EN IEC 61000-4-3:2020 Criterion A**
- **EN 61000-4-4:2012 Criterion A**
- **EN 61000-4-5:2014 + A1:2017 Criterion B**
- **EN 61000-4-6:2014 Criterion A**

END OF THE REPORT